

● PIPE FITTING

PRODUCT DRAWINGS AND DIMENSIONS:

Oil tube connector

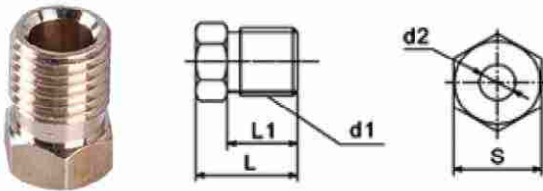

Model	Tube out dia	d1	d2	L	L1	S
GN-4	Ø4	M8*1.0	4.2	12.5	8	8
GN-6	Ø6	M10*1.0	6.2	13	8.5	10
GN-8	Ø8	M12*1.0	8.2	14	8.5	12
GN-8	Ø8	M12*1.25	8.2	14	8.5	12
GN-8	Ø8	M12*1.5	8.2	14	8.5	12
GN-10	Ø10	M16*1.5	10.2	16	11	16

Double cone ferrule

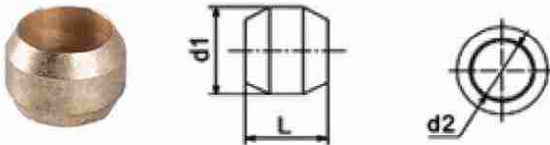

Model	Tube out dia	d1	d2	L
GB-4	Ø4	6	4.1	5
GB-6	Ø6	8	6.1	5.5
GB-8	Ø8	10	8.1	7
GB-10	Ø10	12.5	10.1	8

Joint nut

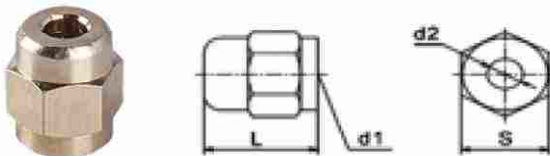

Model	Tube out dia	d1	d2	L	S
GL-4	Ø4	M8*1.0	4.2	13	10
GL-6	Ø6	M10*1.0	6.2	13	12

Nylon tube bushing

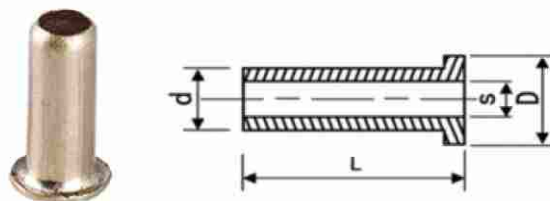

Model	Tube out dia*Wall thickness	D	d	S	L
GP-4*2.5	Ø4*0.75	3.8	2.5	Ø1.8	10.5
GP-4*2	Ø4*1.0	3.8	2	Ø1.2	10.5
GP-6*4	Ø6*1.0	5.8	4	Ø3.3	12
GP-8*6	Ø8*1.0	7.8	6	Ø5	13
GP-10*7	Ø10*1.0	9.8	7	Ø6.6	15
GP-10*8	Ø10*1.0	9.8	8	Ø6.6	15

Oil plug

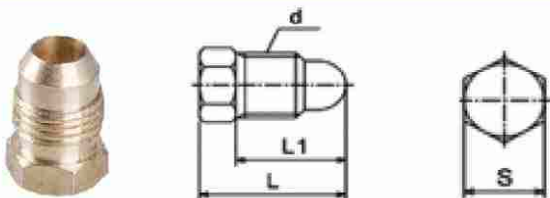

Model	Tube out dia	d1	L	L1	S
GH-4	Ø4	M8*1.0	15	12	8
GH-6	Ø6	M10*1.0	16	13	10

Oil plug

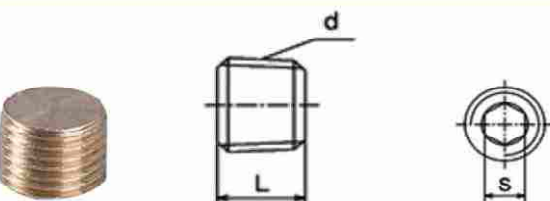

Model	d	L	S
GH-1	R1/4	8	6
GH-2	R1/8	7	5
GH-1A	NPT1/8	7	5

● PIPE FITTING

PRODUCT DRAWINGS AND DIMENSIONS:

Straight connector

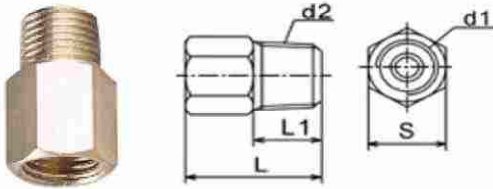

Model	Tube outdia	d1	d2	L	L1	S
JS-41	Ø4	M8×1.0	R1/8	18	8	11
JS-41A		M8×1.0	NPT1/8	18	8	11
JS-46		M8×1.0	M6×1.0	18	8	11
JS-46A		M8×1.0	M6×0.75	18	8	11
JS-48		M8×1.0	M8×1.0	18	8	11
JS-40		M8×1.0	M10×1.0	18	8	11
JS-42	Ø6	M8×1.0	R1/4	20	8	12
JS-61		M10×1.0	R1/8	20	8	12
JS-61A		M10×1.0	NPT1/8	20	8	12
JS-60		M10×1.0	M10×1.0	20	8	12
JS-62		M10×1.0	R1/4	20	8	12
JS-68		M10×1.0	M8×1.0	20	8	12

Right angle joint

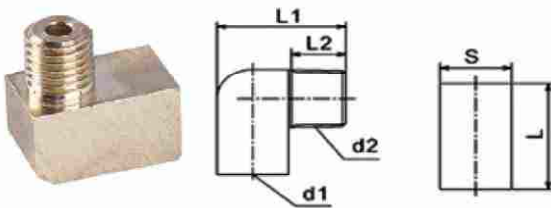

Model	Tube outdia	d1	d2	L	L1	L2
JS-41A	Ø4	M8×1.0	NPT1/8	20	20	8
JN-46A		M8×1.0	M6×0.75	18	18	8
JN-41		M8×1.0	R1/8	18	18	8
JN-46		M8×1.0	M6×1.0	18	18	8
JN-48		M8×1.0	M8×1.0	18	18	8
JN-40		M8×1.0	M10×1.0	20	20	8
JN-42	Ø6	M8×1.0	R1/4	20	18	8
JN-61		M10×1.0	R1/8	20	20	8
JN-61A		M10×1.0	NPT1/8	22	22	8
JN-60		M10×1.0	M10×1.0	20	20	8
JN-66		M10×1.0	M6×1.0	20	20	8
JN-68		M10×1.0	M8×1.0	20	20	8
JN-81	Ø8	M12×1.0	R1/8	25	25	9

Flat right angle joint

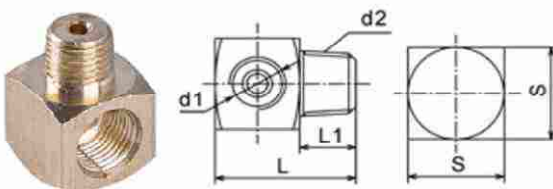

Model	Tube outdia	d1	d2	L	L1	S
JM-41	Ø4	M8×1.0	R1/8	20	8	14
JM-41A		M8×1.0	NPT1/8	20	8	14
JM-46		M8×1.0	M6×1.0	20	8	14
JM-48		M8×1.0	M8×1.0	20	8	14
JM-61	Ø6	M10×1.0	R1/8	22	8	16
JM-66		M10×1.0	M6×1.0	22	8	16
JM-68		M10×1.0	M8×1.0	22	8	16

Flat right angle joint

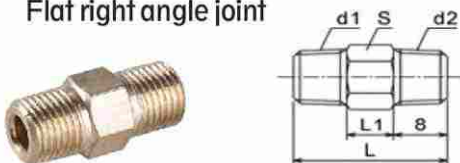

Model	Tube outdia	d1	d2	L	L1	S
JSW-41	Ø4	R1/8	R1/8	17	3	10
JSW-48		M8×1.0	M8×1.0	20	5	10
JSW-40	Ø6	M8×1.0	M8×1.0	25	6.5	11

● PIPE FITTING

PRODUCT DRAWINGS AND DIMENSIONS:

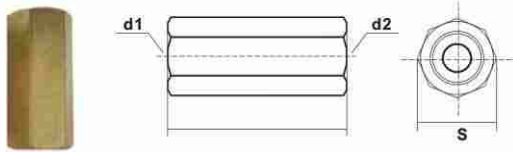

Double straight joint

Model	Tube outdia	d1	d2	L	S
CM-4	Ø4-Ø4	M8×1.0	M8×1.0	25	10
CM-4-6	Ø4-Ø6	M8×1.0	M10×1.0	27	12
CM-6	Ø6-Ø6	M10×1.0	M10×1.0	28	12

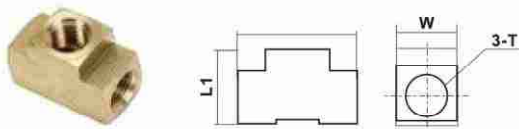

Three way connector

Model	T	L1	L2	W
FKS-01	1/8	23	19	13
FKS-02	1/4	28	23	17

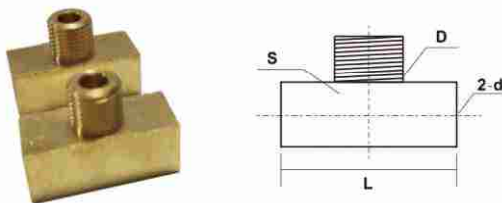

Positive external tee

Model	D	d	L	S
FZS-01	M8×1.0	M8×1.0	28	12
FZS-02	M10×1.0			
FZS-03	R1/8			
FZS-04	M8×1.0	M10×1.0	30	
FZS-05	M10×1.0			
FZS-06	R1/8			

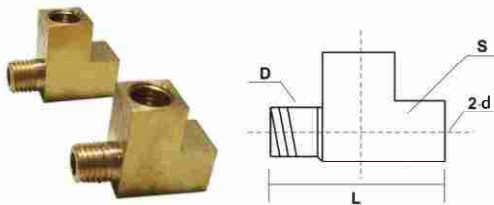

Side external tee

Model	D	d	L	S
FCS-01	M8×1.0	M8×1.0	28	12
FCS-02	M10×1.0			
FCS-03	R1/8			
FCS-04	M8×1.0	M10×1.0	30	
FCS-05	M10×1.0			
FCS-06	R1/8			

● PIPE FITTINGS

PRODUCT DRAWINGS AND DIMENSIONS:

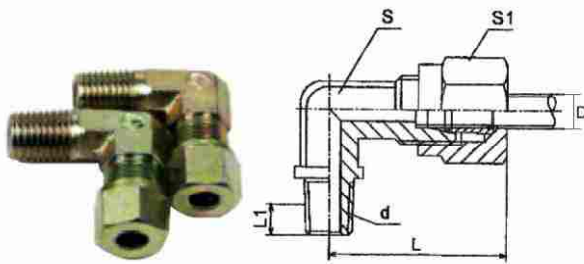

Model	D Tube outdia (mm)	d (Another side)	Shape
KTSW 6-1/4	φ6	R1/4	90°Angle
KTSW 6-1/8		R1/8	
KTSW 6-M10		M10*1	
KTSW 8-1/4	φ8	R1/4	
KTSW 8-1/8		R1/8	
KTSW 10-1/4	φ10	R1/4	

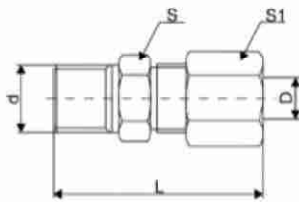

Model	D Tube outdia (mm)	d (Another side)	Shape
KTSZ 6-1/4	φ6	Thread :R1/4	Straight
KTSZ 6-1/8	φ6	Thread :R1/8	
KTSZ 8-1/4	φ8	Thread :R1/4	
KTSZ 8-1/8	φ8	Thread :R1/8	
KTSZ 10-1/4	φ10	Thread :R1/4	

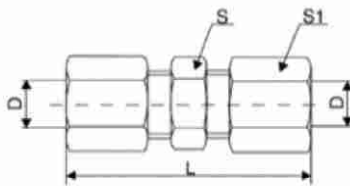

Model	D Tube outdia (mm)	D Tube outdia (mm)	Shape
GLZ 6-6	φ6	φ6	Straight
GLZ 8-8	φ8	φ8	
GLZ 10-10	φ10	φ10	
GLZ 12-12	φ12	φ12	
GLZ 14-14	φ14	φ14	
GLZ 16-16	φ16	φ16	

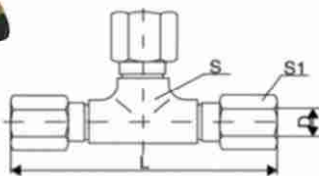

Model	D Tube outdia (mm)	S1	Shape
KTST-6	φ6	12	3way
KTST-8	φ8	14	
KTST-10	φ10	17	

● PIPE FITTINGS

PRODUCT DRAWINGS AND DIMENSIONS:

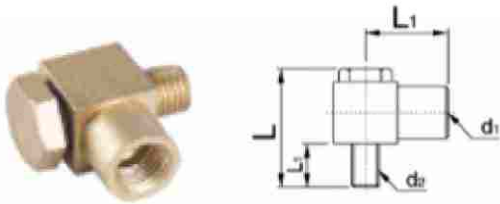

Model	Outdia of pipe	d1	d2	L	L1	S
WJ-4	Φ 4, Φ 4	M8*1	M8*1	25	8	12
WJ-6	Φ 6, Φ 6	M10*1	M10*1	29	10	14

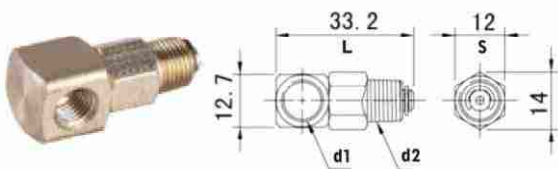

Model	Outdia of pipe	d1	d2	L	S
WS-4	Φ 4, Φ 4	M8*1	R1/8	33.2	12

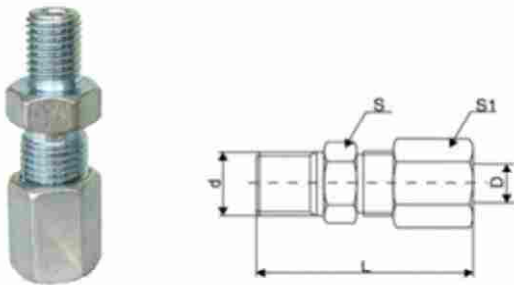

Type	D Tube outdia	d (Another side)	S	S1	L	Shape
KT 61 (6-M6X1)	6 (M10*1)	M6X1	11	12	30	Straight
KT 62 (6-M8X1)		M8*1	11	12	30	
KT 63 (6-M10X1)		M10X1	11	12	30	
KT 64 (6-R1/8)		R1/8	11	12	30	

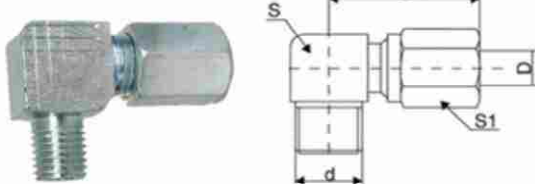

Type	D Tube outdia	d (Another side)	S	S1	L	Shape
KT 61A (6-M6X1)	6 (M10*1)	M6X1	11	12	26	90°Angle
KT 62A (6-M8X1)		M8*1	11	12	26	
KT 63A (6-M10X1)		M10X1	11	12	26	
KT 64A (6-R1/8)		R1/8	11	12	26	

● OIL BRUSHES

PRODUCT PICTURES DIMENSIONS:



Oil-proof discoloration, oil delivery and cooling

Material :	Nylon Brush
Working Temperature :	-10°C - 70°C

Type	Description
YS-4-A	Inner threading M8*1
YS-4-B	4mm Oil tube connector + Double cone oil tube Sleeve
YS-4-C	Outer threading M8*1
YS-6-A	Inner threading M10*1
YS-6-B	with 6mm connector + Double cone oil tube Sleeve
YS-6-C	Outer threading M10*1

NOTICE :

- Use a brush to regularly refuel the inner and outer chain plates at the loose side of the chain, 8 hours/Time
- The quantity and period of oil should be sufficient to prevent the lubricating oil at the chain loop from discoloring.
- In the high speed range (U greater than 5m / s); In the low speed range (U less than 1m / s)
- When the speed is extremely high, fill lubricating oil to reduce temperature by force .Temperature should not exceed 70 °C.

FEATURES:

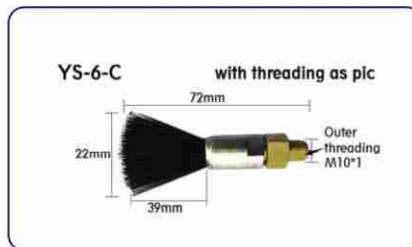
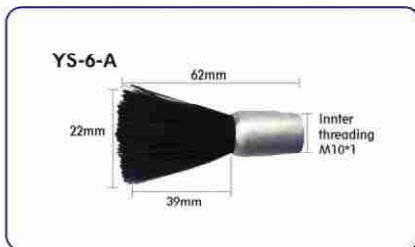
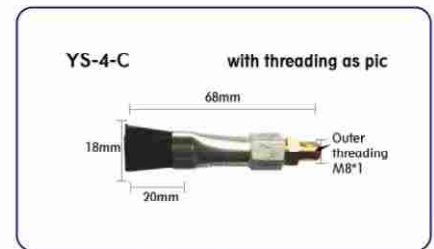
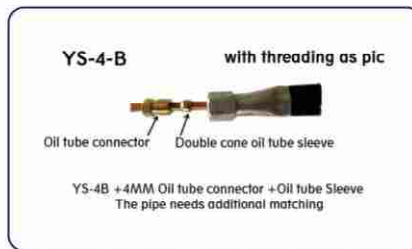

● SPRING TUBE SPRING SHEATH

PRODUCT PICTURES DIMENSIONS:



Type	Inner Dia mm	Out Dia mm	spring material diameter	Weight
TH-4	4.4	5.6	0.6	200g
TH-6	6.4	7.8	0.7	250g
TH-8	8.4	10	0.8	300g
TH-10	10.4	12.2	0.9	350g

DESCRIPTION :

- Spring sheath use for Oil lubrication system
- Use for all Poor environment
- Applicable temperature: -10 °C-80 °C
- Uses: High strength, stable elasticity, excellent hardness, no gap, whole seal, single 4M can stand upright and follow the movement of the equipment guide rail, which can effectively protect the oil pipe from being cut and damage by high temperature.

● TUBE CLAMP

PRODUCT PICTURES DIMENSIONS:

Material :	Steel
Working Temperature :	-10℃-70℃

Product pictures	Type	Tube outdia	Clamp pipe number
	PCB-6-1	Ø6	1 tube
	PCB-6-2		2 tube
	PCB-6-3		3 tube
	PCB-6-4		4 tube
	PCB-8-1	Ø8	1 tube
	PCB-8-2		2 tube
	PCB-8-3		3 tube
	PCB-8-4		4 tube
	PCB-10-1	Ø10	1 tube
	PCB-10-2		2 tube
	PCB-10-3		3 tube
	PCB-10-4		4 tube
	PCB-12-1	Ø12	1 tube
	PCB-12-2		2 tube
	PCB-12-3		3 tube
	PCB-12-4		4 tube

Product pictures	Type	Tube outdia	Clamp pipe number
	PC-4-1	Ø4	1 tube
	PC-4-2	Ø4	2 tube
	PC-4-3	Ø4	3 tube
	PC-4-4	Ø4	4 tube
	PC-6-1	Ø6	1 tube
	PC-6-2	Ø6	2 tube
	PC-6-3	Ø6	3 tube
	PC-6-4	Ø6	4 tube
	PC-8-1	Ø8	1 tube
	PC-10-1	Ø10	1 tube

● CONNECTING ELEMENTS

DESCRIPTION :

The pipelines of $\phi 4$ and $\phi 6$ are diverted through their relays. The combination connection of GN-4, GN-6 tubing joint , GB-4 and GB-6 double cone sleeve should be used.

PRODUCT DRAWINGS AND DIMENSIONS:

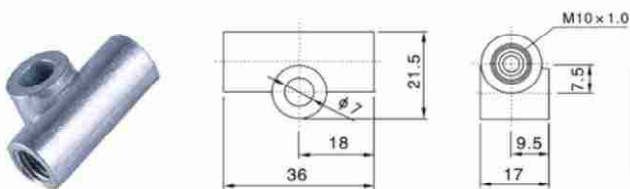

Model	Two way thread	Style
PV-2-6	M10X1	2 Way
PV-2-4	M8X1	2 Way

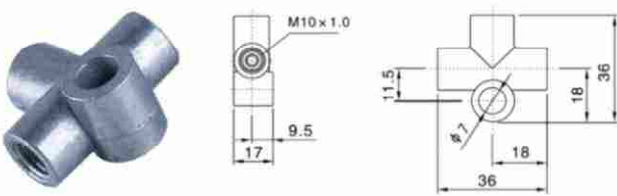

Model	Two way thread	Style
PV-3-6	M10X1	3 Way
PV-3-4	M8X1	3 Way

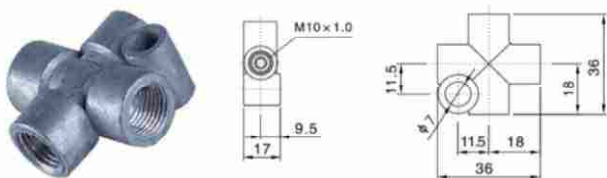

Model	Two way thread	Style
PV-4-6	M10X1	4 Way
PV-4-4	M8X1	4 Way

● PV/PVS RESISTANCE DISTRIBUTOR (FOR RESISTANCE SYSTEM)

PRODUCT DRAWINGS AND DIMENSIONS :

1. The distributor is divided into two categories: single split and Double-way split. Used in resistive lubrication systems.
2. The $\Phi 4/\Phi 6$ main oil pipeline through it to divert. Inlet/Outlet threads are M8X1/M10x1 which is matched by GN-4/GN-6 oil pipe connector and GB-4/GB-6 Oil Pipe Sleeve
3. The resistive FHA metering element delivers the oil directly through it to the lubrication point.
4. Connect the equipment directly is FHB metering element.



SPECIFICATION :

PRODUCT CODE : 10506-1

	Model No.	Oil Outlet Qty	Outsize (MM)		Inlet Threading	Outlet Threading
			L	L1		
	PV-4	2	47	35	M8X1 (For $\Phi 4$)	M8X1 (For $\Phi 4$)
	PV-5	3	63	51		
	PV-6	4	79	67		
	PV-7	5	95	83		
	PV-8	6	111	99		
	PV-9	7	127	115		
	PV-10	8	143	131		
	PV-11	9	152	142		
	PV-12	10	159	147		

SPECIFICATION :

PRODUCT CODE : 10506-2

	Model No.	Oil Outlet Qty	Outsize (MM)		Inlet Threading	Outlet Threading
			L	L1		
	PV-664 -4	2	47	35	M10X1 (For $\Phi 6$)	M8X1 (For $\Phi 4$)
	PV-664 -5	3	63	51		
	PV-664 -6	4	79	67		
	PV-664 -7	5	95	83		
	PV-664 -8	6	111	99		
	PV-664 -9	7	127	115		
	PV-664 -10	8	143	131		
	PV-664 -11	9	152	142		
	PV-664 -12	10	159	147		

● PV/PVS RESISTANCE DISTRIBUTOR (FOR RESISTANCE SYSTEM)

SPECIFICATION :

PRODUCT CODE : 10506-3

	Model No.	Oil Outlet Qty	Outsize (MM)		Inlet Threading	Outlet Threading
			L	L1		
	PV-6D	4	47	35	M8X1 (For Φ 4)	M8X1 (For Φ 4)
PV-8D	6	63	51			
PV-10D	8	79	67			
PV-12D	10	95	83			

SPECIFICATION :

PRODUCT CODE : 10506-4

	Model No.	Oil Outlet Qty	Outsize (MM)		Inlet Threading	Outlet Threading
			L	L1		
	PVS-4	2	50	35	M10X1 (For Φ 6)	M10X1 (For Φ 6)
PVS-5	3	65	50			
PVS-6	4	80	65			
PVS-7	5	95	80			
PVS-8	6	111	95			
PVS-9	7	125	110			
PV-10	8	140	125			
PV-12	10	170	155			

● HT TYPE ADJUSTABLE OIL DISTRIBUTOR (FOR RESISTANCE SYSTEM)

DESCRIPTION / PRODUCT DRAWINGS AND DIMENSIONS

- Applicable to the thin oil and butter lubrication system , the oil can be adjusted arbitrarily , and each oil outlet is provided with a check valve to prevent the oil from being discharged. Counterflow , can be used with interval type oil lubrication pump , continuous oil lubrication pump and manual butter lubrication pump.

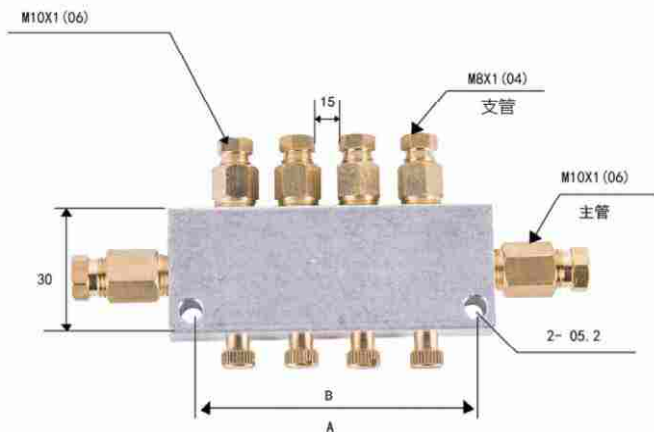
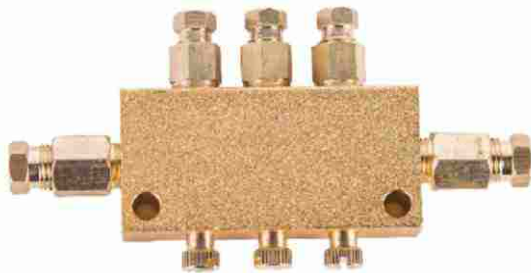

SPECIFICATION :

PRODUCT CODE : 10507

Model	Inlet Oil Pipe Dia	Oil Out	A	B	Nominal Pressure Mpa	Out Let Pipe Didmeter	Nominal Flow Rate	Flow Rate
HT-2	Φ4mm Φ6mm	2	47	37	0.8	Φ4mm Φ6mm	Adjusted	Adjusted
HT-3		3	62	52				
HT-4		4	77	67				
HT-5		5	92	82				
HT-6		6	107	97				
HT-7		7	122	112				
HT-8		8	137	127				
HT-9		9	152	142				
HT-10		10	167	157				

● T86 OIL PRESSURE QUANTITATIVE DISPENSER

DESCRIPTION:

Also called volumetric type, it is a pressurized action type. The pressure oil delivered by the lubrication pump pushes the piston in the measuring piece, and the oil that has been stored in the chamber of measuring part forcibly pressurized to the lubrication point. When the system is unloaded, re-storage the oil in the chamber to prepare for the next work.

The system must be operated intermittently and the associated lubrication pump must have an unloading function. The lubrication pump has a working cycle, the measuring parts only make oil once, and the distance between the measuring parts is far, near, high, low, horizontal or vertical has no influence for oil outlet.

Accurate measurement, quick action, Smooth drain, the check valve prevents oil from flowing back.

PRODUCT DRAWINGS :

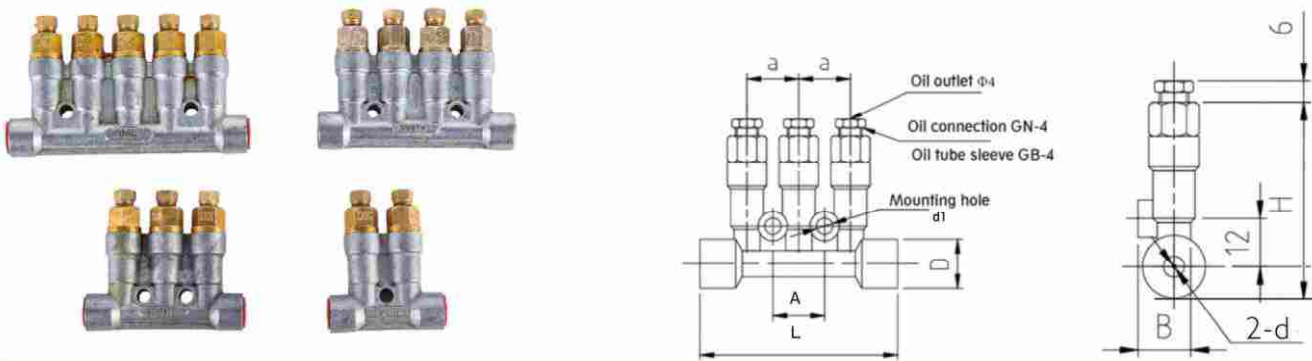

SPECIFICATION :

Model No.	Number of Outlet	Working Pressure	Apply oil	Standard Flow can choose (ml/cyc)	Mark	d	(d1) Mounting hole	A	B	H	H1	D	L					
T8615*	1	2.0 Mpa	32-1300cst	A(0.03)	3	M10X1	/	/	/	/	/	/	/					
T8616*	2			B(0.06)	6		3-Φ 5.5	/	/	18	Φ	16	46					
T8617*	3			C(0.10)	10		2-Φ 5.5	17	14	58				16	63			
T8619*	4			D(0.16)	16			34	80									
T8618*	5							51		97								
T8621*	1			A(0.10)	10	M12X1.25	/	/	/	/				/	/	/		
T8622*	2			B(0.20)	20		6	/	/	17	72	17	Φ	18	46			
T8623*	3			C(0.40)	40		2-Φ 6	17	16							86	18	71
T8620*	4			D(0.60)	60			34										
T8624*	5						51	97										
T8625*	1			A(0.20)	20	M12X1.25	/	/	/	/	/	/	/					
T8626*	2			B(0.40)	40		6	/	/	16	86	18	Φ	18	50			
T8627*	3			C(0.60)	60		2-Φ 6	21	16							86	18	71
T8629*	4			D(1.00)	100			42										
T8628*	5						E(1.50)	150	63	113								

SELECTION CONSIDERATIONS:

- ◆ Mean the mark for Oil flow (A, B, C, D),
- ◆ For example : T8617C , The three outlets of are all 0.10mL.
- ◆ T8617-BCD mean-Oil outlet from left to right , Oil flow is 0.06, 0.1, 0.16
- ◆ If it is a grease dispenser, add "Z" after the model number.

ZLFG OIL PRESSURE QUANTITATIVE DISPENSER

DESCRIPTION :

- ZLFG volumetric distributor, stores oil when the system is pressurized, and be oiling when the system is depressurized. This series can quantitatively deliver the lubricating oil to each lubrication point according to the specified main oil quantity specification.
- ZLFG series have two outlets, three outlets, four outlets, five outlets , They are widely used in lubrication systems for printing , plastics , packaging, cnc machine and other mechanical equipment.

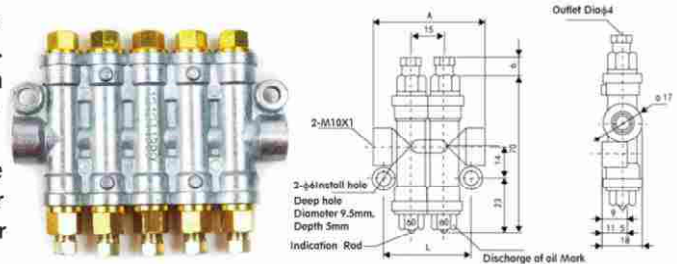

THE SPECIFICATIONS AND TECHNICAL PARAMETERS: PRODUCT CODE : 600504

Model No.	Outlet	Oil	Standard Working Pressure (Mpa)	*Discharge Oil Size Mark						Outsize	
				1	2	3	4	5	6	L	A
				Oil flow (ml/time) /Mark							
ZLFG2_*	2way	32-1300cst	1.0-2.0	0.1/10	0.2/20	0.3/30	0.4/40	0.5/50	0.6/60	39	49
ZLFG3_*	3way									54	64
ZLFG4_*	4way									72	82
ZLFG5_*	5way									84	94

NOTICE:

- The volumetric distributor is a pressure-reducing action type, the pressure oil delivered by the lubrication pump pushes the piston in the metering part, and the oil is stored in the chamber, and the indicator rod is extended. When the system is unloaded, under the action of the spring, the piston forcibly pressed the oil from chamber to the lubrication point, and the indicator rod is retracted.
- The system must be operated intermittently and the lubrication pump must have an unloading function.
- Each working cycle for Lubrication pump, oil outlet only oil one time, and the distance between the measuring parts are far, near, high, low, lying or loaded have no effect on the displacement.

RH OIL PRESSURE VOLUMETRIC DISTRIBUTOR

DESCRIPTION :

- RH volumetric distributor, stores oil when the system is pressurized, and be oiling when the system is depressurized. This series can quantitatively deliver the lubricating oil to each lubrication point according to the specified main oil quantity specification.
- RH series have two outlets, three outlets, four outlets, five outlets , and four outlet ports. They are widely used in lubrication systems for printing , plastics , packaging, cnc machine and other mechanical equipment..

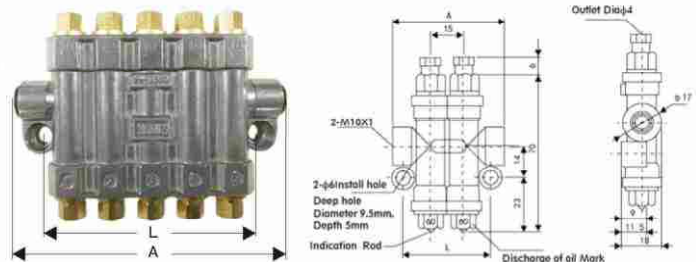

THE SPECIFICATIONS AND TECHNICAL PARAMETERS: PRODUCT CODE : 600505

Model No.	Outlet	Oil	Standard Working Pressure (Mpa)	*Discharge Oil Size Mark				Outsize	
				1	2	3	4	L	A
				Oil flow (ml/time) /Mark					
RH-3200	2way	32-1300cst	1.0-2.0	0.1/10	0.2/20	0.3/30	0.4/40	39	49
RH-3300	3way							54	64
RH-3400	4way							72	82
RH-3500	5way							84	94

NOTICE:

The volumetric distributor is a pressure-reducing action type, the pressure oil delivered by the lubrication pump pushes the piston in the metering part, and the oil is stored in the chamber, and the indicator rod is extended. When the system is unloaded, under the action of the spring, the piston forcibly pressed the oil from chamber to the lubrication point, and the indicator rod is retracted.

The system must be operated intermittently and the lubrication pump must have an unloading function.

Each working cycle for Lubrication pump, oil outlet only oil one time, and the distance between the measuring parts are far, near, high, low, lying or loaded have no effect on the displacement.

WORKING DRAWINGS :

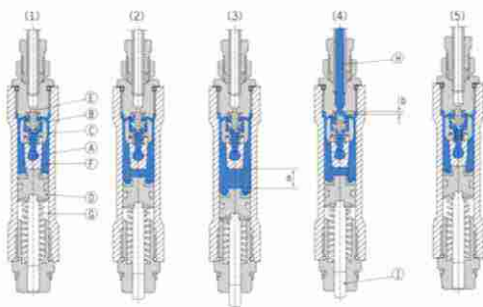

- 1st >> The oil which sent by the lubrication pump is injected by the main pipe A,
- 2nd >> umbrella-shaped two-way valve B is pushed upward and through the passage C flows into the piston chamber F.
- 3rd >> Under the action of the pressure oil, the metering piston moves downward, and the spring G is compressed and accumulated, and the oil is stored and start metering .
- 4th >> When the oil pressure in the main pipe A is released (pressure released), the umbrella valve B moves downward due to the pressure , and spit the exit E, so that the metering oil in the piston enters the oil pipe H through the discharge port E, and the oil is delivered to the lubrication station,
- 5th >> the signal pin protrudes when metered, and retracted when supply oil to the lubrication station

● MO PRESSURIZED QUANTITATIVE OIL TYPE (VOLUMETRIC TYPE)

DESCRIPTION

- The pressurized quantitative type (volumetric type) measuring piece is a direct pressure type. Depending on the type of connecting thread,
- The pressure oil delivered by the lubrication pump pushes the piston built in the metering member to force the discharge of the quantitative oil; When the lubrication pump stops working, the measuring piece is reset by the spring force, the metering and storing the quantitative oil.
- The oil discharge is accurate. The metering parts are only drained once in a single oil supply cycle, and the distance between the two in the lubrication system is far, near, high, and low. The horizontal or vertical installation has no effect on the displacement of the measuring parts.
- Forced to drain oil, sensitive action. Two seals are used to prevent the discharged oil from flowing back.
- The measuring piece and the oil row are in a split structure, and the corresponding measuring piece can be arbitrarily selected according to the demand of each lubricating point, and can be used freely in combination with the RH series and the T86, ALFG series oil row.
- The diameter of the oil outlet of the metering part is $\varnothing 4$.
- Oil inlet Thread Can choose R1/8, M8*1, Oil Outlet Thread Size M8*1, Match 4mm oil pipe.

WORKING PRINCIPLE DIAGRAM:

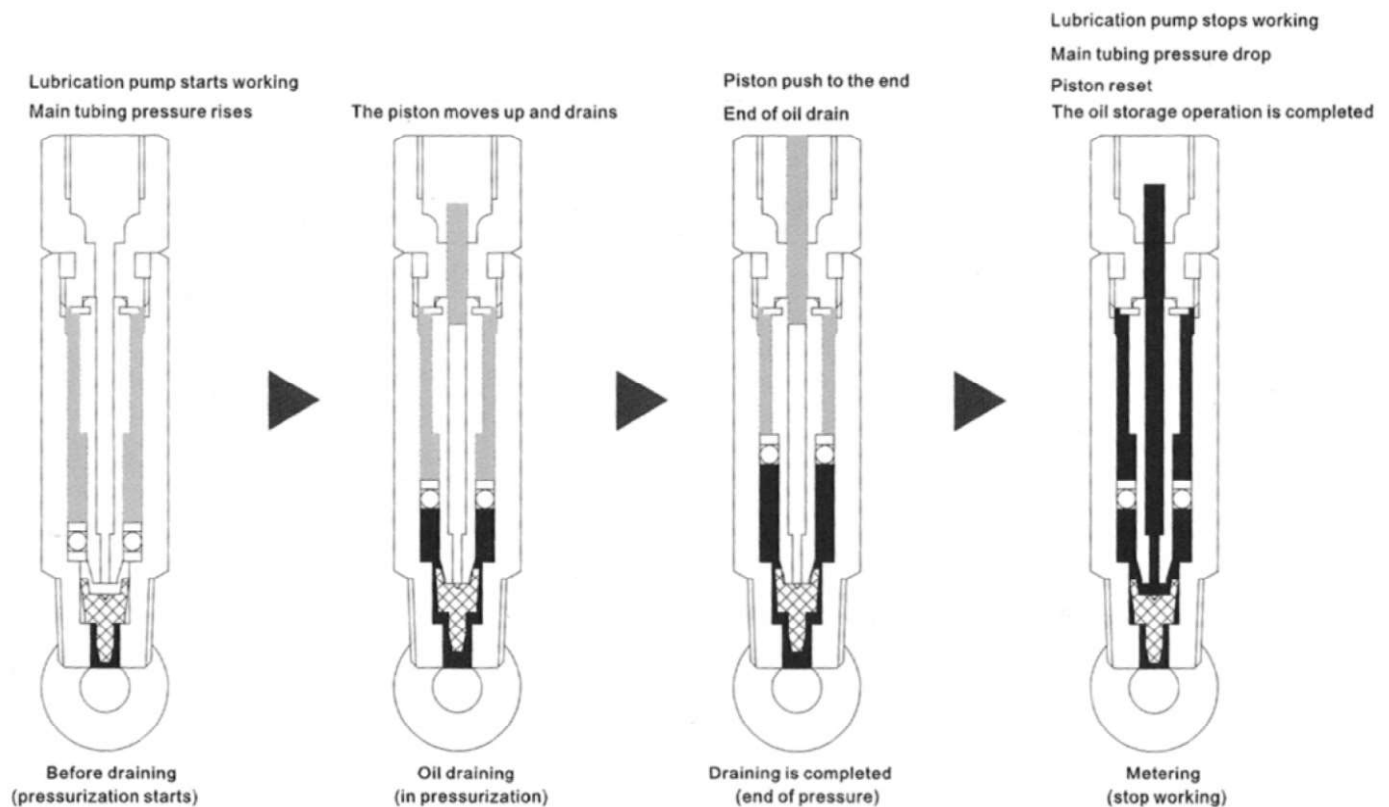

● MO PRESSURIZED QUANTITATIVE OIL TYPE (VOLUMETRIC TYPE)

PRODUCT DRAWINGS AND DIMENSIONS

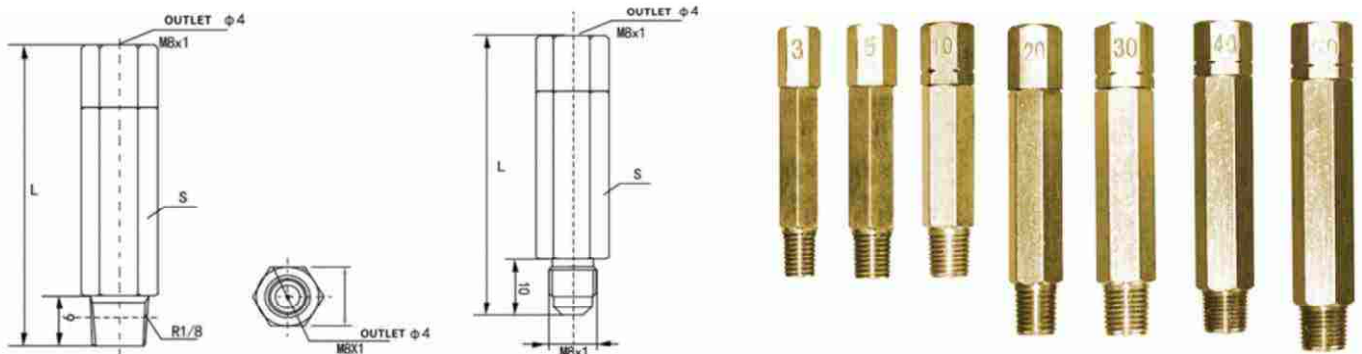

SPECIFICATION :

PRODUCT CODE : 600502-1

Inlet Thread Spec	Outlet Thread /Outlet Pipe Dia (mm)	Model	Nominal Displacement	Mark	Highest pressure (Mpa)	Action pressure (Mpa)	Reset Pressure (Mpa)	L(MM)
R1/8	M8X1, Φ 4mm	MO-3	0.03	3	8	6	0.3	44.5
		MO-5	0.05	5				
		MO-10	0.1	10				
		MO-20	0.2	20				53.5
		MO-30	0.3	30				
		MO-40	0.4	40				
		MO-50	0.5	50				
								65

SPECIFICATION :

PRODUCT CODE : 600502-2

Inlet Thread Spec	Outlet Thread /Outlet Pipe Dia (mm)	Model	Nominal Displacement	Mark	Highest pressure (Mpa)	Action pressure (Mpa)	Reset Pressure (Mpa)	L(MM)
M8x1	M8X1, Φ 4mm	MO-3	0.03	3	8	6	0.3	44.5
		MO-5	0.05	5				
		MO-10	0.1	10				
		MO-20	0.2	20				53.5
		MO-30	0.3	30				
		MO-40	0.4	40				
		MO-50	0.5	50				
								65

● MG PRESSURIZED QUANTITATIVE GREASE TYPE (VOLUMETRIC TYPE)

PRODUCT DRAWINGS AND DIMENSIONS

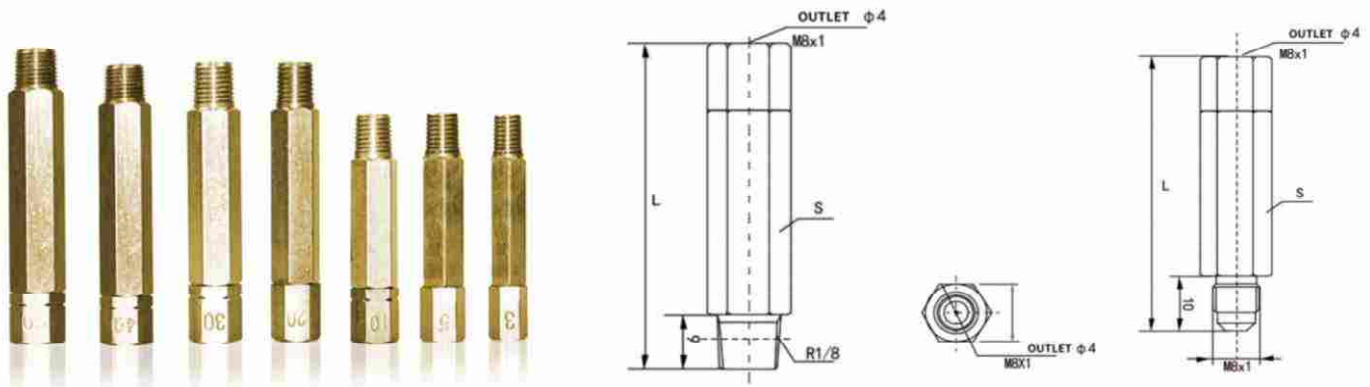

SPECIFICATION :

PRODUCT CODE : 600502-3

Inlet Thread Spec	Outlet Thread /Outlet Pipe Dia	Model	Nominal Displacement (ML/CYC)	Mark	Highest pressure (Mpa)	Action pressure (Mpa)	Reset Pressure (Mpa)	L(MM)
R1/8	M8X1, φ4mm	MG-3	0.03	3	8	6	0.3	44.5
		MG-5	0.05	5				
		MG-10	0.1	10				
		MG-20	0.2	20				53.5
		MG-30	0.3	30				
		MG-40	0.4	40				
		MG-50	0.5	50				
							65	

SPECIFICATION :

PRODUCT CODE : 600502-4

Inlet Thread Spec	Outlet Thread /Outlet Pipe Dia	Model	Nominal Displacement	Mark	Highest pressure (Mpa)	Action pressure (Mpa)	Reset Pressure (Mpa)	L(MM)
M8x1	M8X1, φ4mm	MG-3	0.03	3	8	6	0.3	44.5
		MG-5	0.05	5				
		MG-10	0.1	10				
		MG-20	0.2	20				53.5
		MG-30	0.3	30				
		MG-40	0.4	40				
		MG-50	0.5	50				
							65	

● MG PRESSURIZED QUANTITATIVE GREASE TYPE (VOLUMETRIC TYPE)

DESCRIPTION

- The pressurized quantitative type (volumetric type) measuring piece is a direct pressure type. Depending on the type of connecting thread,
- The pressure grease delivered by the lubrication pump pushes the piston built in the metering member to force the discharge of the quantitative. Inlet Thread Can choose R1/8, M8*1, Outlet Thread Size M8*1, Match 4mm pipe; When the lubrication pump stops working, the measuring piece is reset by the spring force, the metering and storing the quantitative grease.
- The grease discharge is accurate. The metering parts are only drained once in a single supply cycle, and the distance between the two in the lubrication system is far, near, high, and low. The horizontal or vertical installation has no effect on the displacement of the measuring parts.
- Forced to drain oil, sensitive action. Two seals are used to prevent the discharged grease from flowing back.
- The measuring piece and the row are in a split structure, and the corresponding measuring piece can be arbitrarily selected according to the demand of each lubricating point, and can be used freely in combination with the RH series and the T86, ZLFG series Distributor.
- Inlet Thread Can choose R1/8, M8*1, Outlet Thread Size M8*1, Match 4mm pipe.

WORKING PRINCIPLE DIAGRAM:

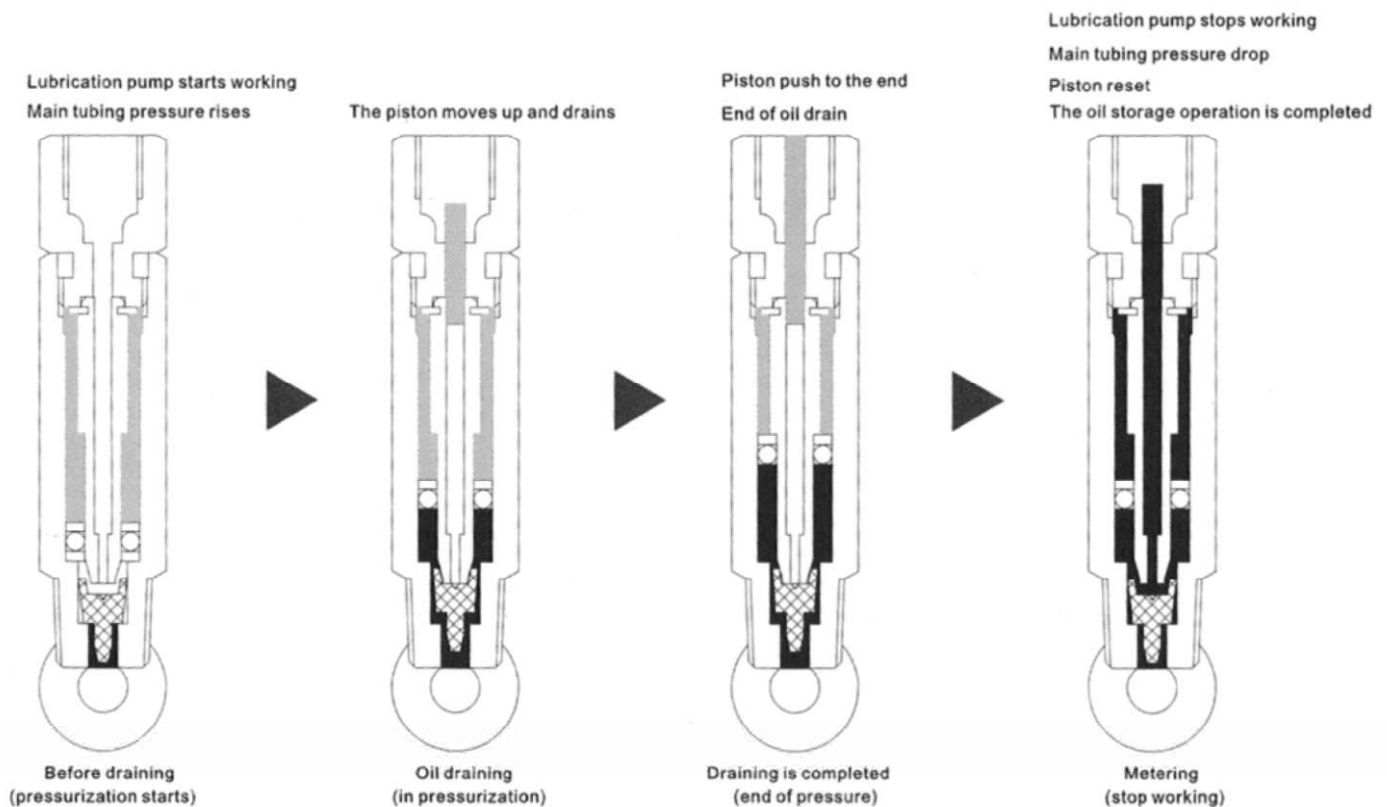

METER UNITS (FOR RESISTANCE SYSTEM)

PRODUCT DRAWINGS AND DIMENSIONS:

- Meter units AJB/DPC are oil proportioning devices for single line resistance cyclic systems
- Each outlet of a Lubricating system is controlled by a meter unit.
- The lubricator in the system dispenses oil to the distribution network and meter units deliver this oil in varying amounts to the friction points .

1. Working Pressure:0.2-2Mpa (2-20kgf/cm²)
2. Oil Viscosity (40c): 20-500cst
3. Flow Rate :The flow will be multiplied via serial number sequenc.
4. connected to PV/PVS distributor. FHB connector to equipment lubrication point

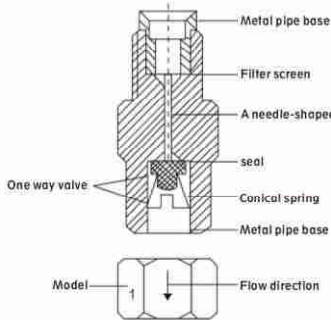

Internal structure diagram

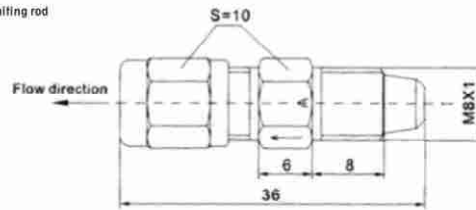

FHA

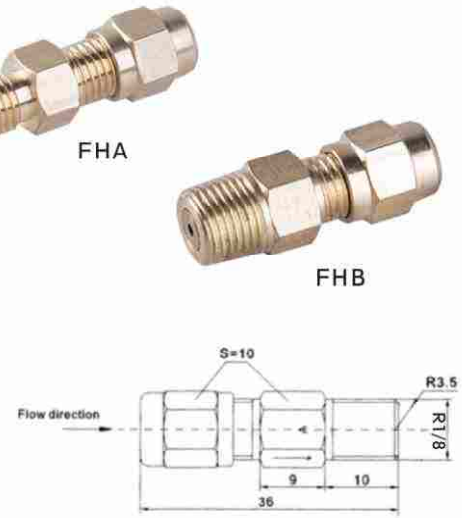

FHB

SPECIFICATION :

PRODUCT CODE : 10505-1

Model Number	Body Mark	Code	Type	L	S	SPE	FLOW RATE	A Inner thread	B Outer Thread	connection method
FHA-00	AJB/DPC	10505-1-00	Meter Unit	36	10	00	2.5	M8X1	M8X1	install with PV/PVS distributor
FHA-0	DPC	10505-1-0				0	5			
FHA-1		10505-1-1				1	10			
FHA-2		10505-1-2				2	20			
FHA-3		10505-1-3				3	40			
FHA-4		10505-1-4				4	80			
FHA-5		10505-1-5				5	160			

SPECIFICATION :

PRODUCT CODE : 10505-2

Model Number	Body Mark	Code	Type	L	S	SPE	FLOW RATE	A Inner thread	B Outer Thread	connection method
FHB-00	AJB/DPC	10505-2-00	Meter Unit	36	10	00	2.5	M8X1	R1/8	install to equipment lubrication point
FHB-0	DPC	10505-2-0				0	5			
FHB-1		10505-2-1				1	10			
FHB-2		10505-2-2				2	20			
FHB-3		10505-2-3				3	40			
FHB-4		10505-2-4				4	80			
FHB-5		10505-2-5				5	160			

● OIL FILTER

PRODUCT PICTURES DIMENSIONS:

- Applicable to the thin oil lubrication system, installed on the lubrication pump outlet line.
- Used to remove or prevent impurities from entering the lubrication system.

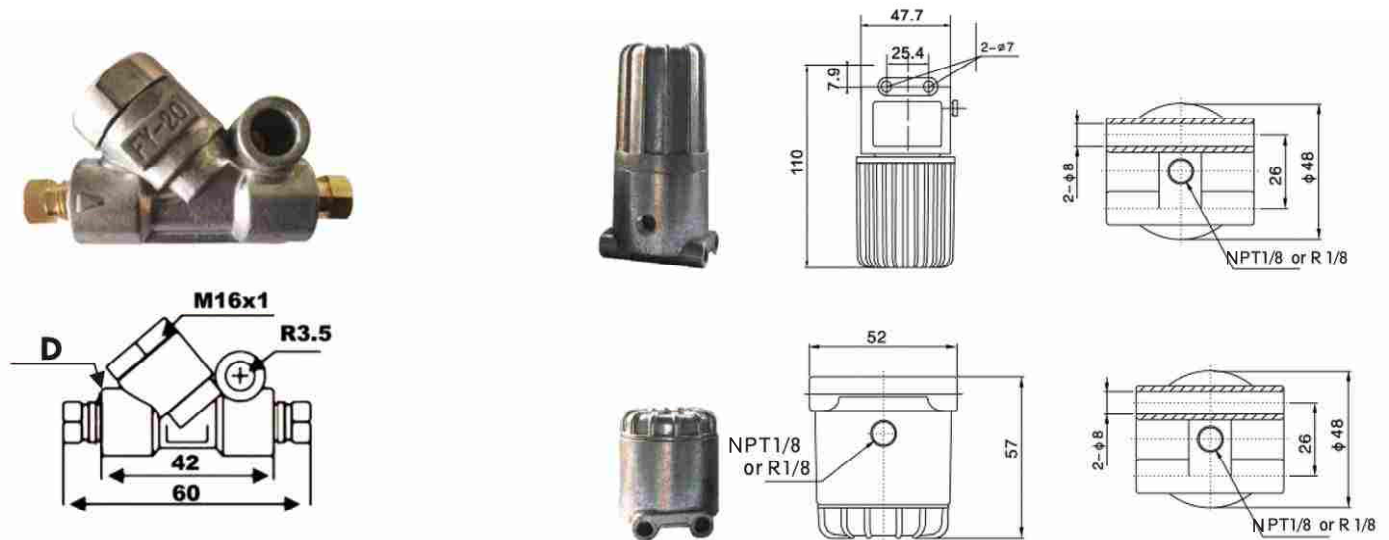

SPECIFICATION

Photo	Type	D Assemble GN+GB (For pipe Dia)	Max Working Pressure (Mpa)	Max Flow (L/Min)	Filtration precision (um)	Oil viscosity
	FY-20-4	M8X1 (4mm)	2.5	1	20	≤2000
	FY-20-6	M10X1 (6mm)	2.5	1	20	

Photo	Type	Hole thread	Max Working Pressure (Mpa)	Max Flow (L/Min)	Filtration precision (um)	Oil viscosity
	SU-25-R	R 1/8	3.5	0.5	25	≤2000
	SU-25-NPT	NPT1/8	3.5	0.5	25	
	SU-125-R	R 1/8	3.5	7	125	
	SU-125-NPT	NPT1/8	3.5	7	125	

CENTRAL LUBRICATION SYSTEM TUBE SERIES

PA PA11 SOLFT NYLON TUBE

PRODUCT DESCRIPTION



Working Temperature -30 °C -120°C

Application: Widely used in mechanical lubrication, as well as visible liquid transport and other ventilation, oil, water

Length can customized MOQ :1M

Size (mm) Outdia x Thickness	Pipe Outdia (D)	Thickness(mm)	Inner dia (d)	Working Pressure	Burst pressure	Abrasion resistance	Surface Hardness	Tensile strength	Bending radius
PA11 4mm*0.75	Φ 4	0.75	2.5	20 °C (2.7Mpa/cm2)	20 °C (4.5Mpa/cm2)	40mg	80D±5	64kgf	62mm
PA11 4mm*1	Φ 4	1	2						
PA11 6mm*1	Φ 6	1	4						
PA11 8mm*1	Φ 8	1	6						
PA11 10mm*1	Φ 10	1	8						

ALUMINUM TUBE

PRODUCT DESCRIPTION



Size : Φ 4/6/8

Thickness : 1 mm

Material : High-density

Length can customized

MOQ :1M

Name	Size (mm) Outdia x Thickness	(D) Pipe Outdia	Thickness (mm)
Aluminum Pipe	4mm*1	Φ 4	1
	6mm*1	Φ 6	1
	8mm*1	Φ 8	1

COPPER TUBE

PRODUCT DESCRIPTION



Size : Φ 4/6/8

Material : High-density

Length can customized

MOQ :1M

Name	Size (mm) Outdia x Thickness	(D) Pipe Outdia	Thickness (mm)
Copper Tube	4mm*0.5	Φ 4	0.5
	6mm*1	Φ 6	1
	8mm*1	Φ 8	1

HOSES, TUBES AND FITTINGS

PRODUCT PICTURES

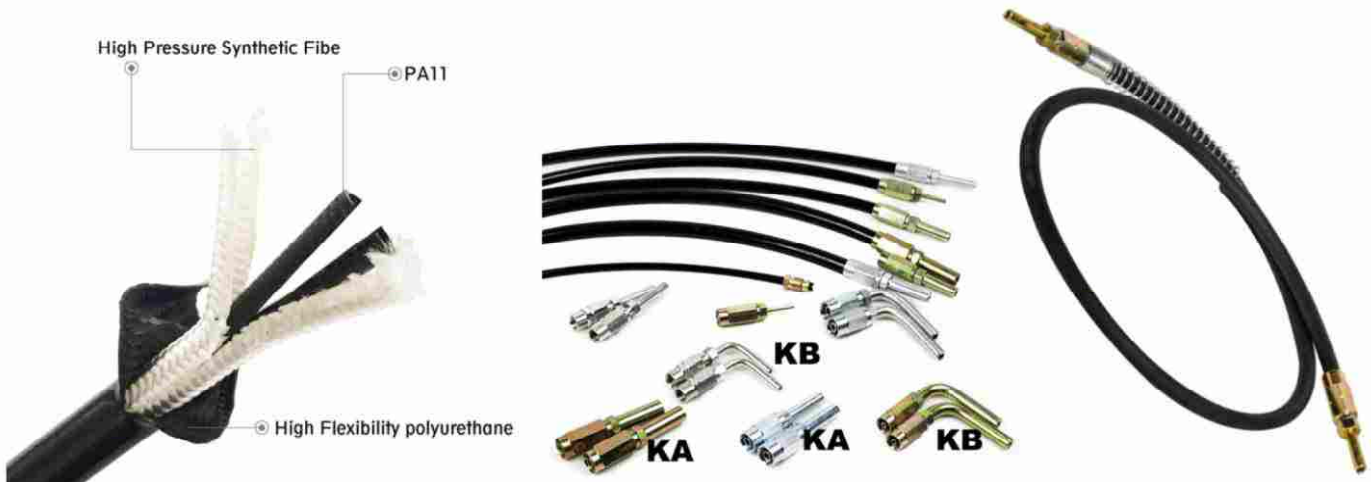

DESCRIPTION:

All necessary tubing, hoses, fittings and fastening material are available to meet your system requirements.

Tubes are available in several sizes and materials ranging from steel, stainless steel, and copper to plastic (PA). To save your time when installing your own systems, plastic tubes are even available pre-filled with grease.

Fittings are also available in several sizes, materials and series (light to heavy). For easy installation, we have special Quicklinec push-in type fittings that can be used with plastic tubes.

HYDRAULIC LUBRICATION HOSE(GREASE HOSE) CHARACTERISTICS

- High pressure hose with grease is equipped with the screw sleeve (threaded sleeve) and a hose stud (pipe fitting) at it's respective line ends and thus ready for connection
- Cost savings, the hose can be taken according to the actual length of use.
- For the installation of the screw sleeve and the hose stud, the mechanic will require no special tools. Easy to disassemble and assemble. Tighten the nut.
- Composite resin hose: This kind of hose is made of inner tube (Pa11), reinforcement (High Pressure Synthetic Fiber), and cover made of three layers of High Flexibility polyurethane). It is Light weight, Flexibility, and the inner tube is very smooth. With a few loss of pressure, the hose resistance of the medium flowing is small, and it also owns a fine performance of Anti-chemical and impulse.
- Applicable to Automobile, Engineering, Machinery, Lathe, Agriculture, Machine, Mining, Spurting the oil paint, aviation & Space flight, Cooling and other Hydraulic Control System.
- Applicable temperature range is -20C - 80C.

In case of occasion, spring sheath protection can be added.

HYDRAULIC LUBRICATION HOSE(GREASE HOSE) SIZE FOR CHOOSE

SPECIFICATION FOR POLYURETHANE TUBE (Lubrication Hose)	
Product features	Max temperature at permanent use +80°C
	Min temperature -20°C
	Slight length deviation at operating pressure less than +-3%
	Neutral reading the most at atmospheric influences
	Good proportion between inside and outside diameter
	low weight

	Size	O.D (mm)	I.D (mm)	W.P working pressure (bar)
Size	8.8x4.2	8.8	4.2	21
	8.6x4.2	8.6	4.2	
	11x6	11	6	
	6x3	6	3	

● HOSES, TUBES AND FITTINGS

HYDRAULIC LUBRICATION HOSE(GREASE HOSE) TO ASSEMBLE WITH FITTINGS

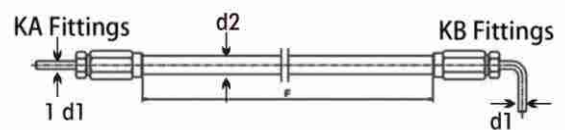
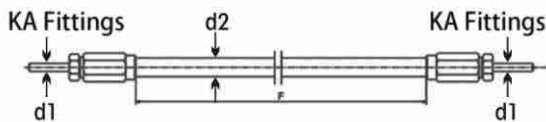

KA Fitting	KA-4	KA-6	KA-8	KA-10	
The pin size for oil Pipe (d1)	Φ4	Φ6	Φ8	Φ10	
Hose to fit (d2)	8.8x4.2	8.6x4.2	8.6x4.2	11x6	
		8.8x4.2	8.8x4.2		
F mm	According customer's need				
W.P working pressure (MPa)	Working pressure 21MPa Maximum bear 25MPa , Maximum burst pressure 84MPa,				

KB Fitting	/	KB-6	KB-8	KB-10	
The pin size (d1)	/	Φ6	Φ8	Φ10	
Hose to fit (d2)	/	8.6x4.2	8.6x4.2	11x6	
		8.8x4.2	8.8x4.2		
F mm	According customer's need				
W.P working pressure (MPa)	Working pressure 21MPa Maximum bear 25MPa , Maximum burst pressure 84MPa,				

AMS-KSEIndonesia Corp

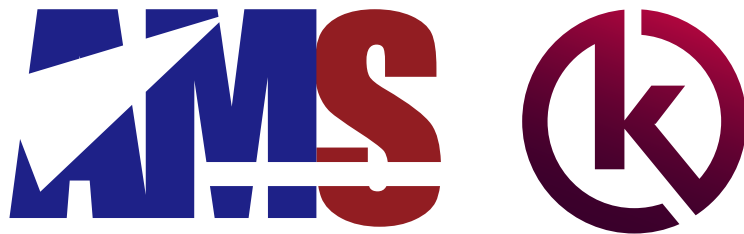

PT. APINDO MITRA SELARAS

Serang Office :

Komp. Lebak Indah Griya Asri
Blok D4-D5 No.17 & No.05
Waringin Kuring - Kramatwatu
Serang, Banten
42161

Cilegon Office :

Jl. Raya Pondok Cilegon Indah
Ruko Cilegon City Square Blok I No.7
Kedaleman - Cibeber
Cilegon, Banten
42422

aris@kseindonesia.com - sales@kseindonesia.com - cso@kseindonesia.com

www.kseindonesia.com